

# AUTOMATIC STRAIGHT FEED CASE ERECTOR ESHB11-2 FOOTPRINT



**WANT TO KNOW MORE  
ABOUT THIS MACHINE?**

SCAN HERE TO LEARN MORE ABOUT THIS MACHINE

**MACHINE  
MEASUREMENTS:**

198.1" X 86.2" X 86.1"  
LENGTH WIDTH HEIGHT

## TOP VIEW

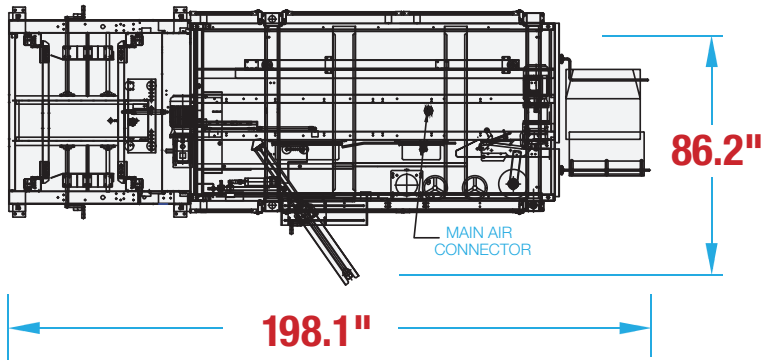

## SIDE VIEW

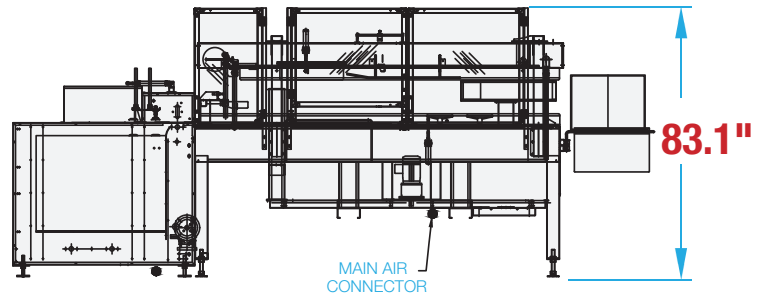

Note: Dimensions are all subject to change without prior notification. Call BestPack for pricing.