

MANUAL AGRICULTURE

CARTON SEALING SOLUTION

BUILT TO SEAL AGRICULTURE PRODUCTS



QUICK HIGHLIGHTS

SEALS UP TO 35 CARTONS PER/MIN.*
*SPEED DEPENDENT ON CARTON SIZE AND MACHINE OPTIONS

- Applies Two Strips of Tape to the Top of the Box for Added Security
- Upper and Bottom Assembly Can Swap Between 2", 3", or 6"
- Automatically Folds Flaps and Grabs Boxes Eliminating Repetitive Operator Movement

CARTON RANGE

Specifications based on MSAG-3HEB

Length (min. - max.)	Width (min. - max.)	Height (min. - max.)
(6.0" - U)	(8.5" - 21.0")	(6.25" - 20.25")

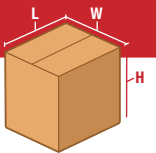

MSAG

MANUAL SIDEDRIVE FOR AGRICULTURE PRODUCTS

The BestPack MSAG is a Semi-Automatic Uniform Tape Carton Sealer designed for unique applications. It efficiently places two tape strips on the top of the carton, ensuring an even distribution to the top edges while maintaining a centered seal at the bottom. The upper and bottom assemblies accommodate center sealing with 2", 3", and 6" tape heads. Complete with the option to seal the top of the carton using either 2" or 3" tape heads and with a top 3-flap folder and front extended side belts, the MSAG is equipped for optimal performance.

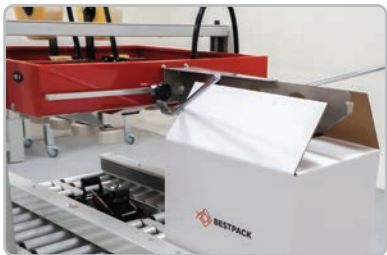

FREE PRODUCT SUPPORT:
TRAINING VIDEOS | ONLINE MANUALS | TECH SUPPORT

*CONTACT YOUR LOCAL BESTPACK REPRESENTATIVE FOR MORE INFORMATION

WWW.BESTPACK.COM

VERSION 5.0_0124

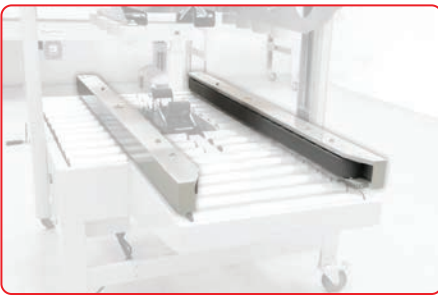

EXTENDED BELT DRIVES

Gently pulls product through while reducing less wear & tear on parts.



TOP FLAP FOLDER

Elimiates repetitive manual folding of flaps, improving worker efficiency.

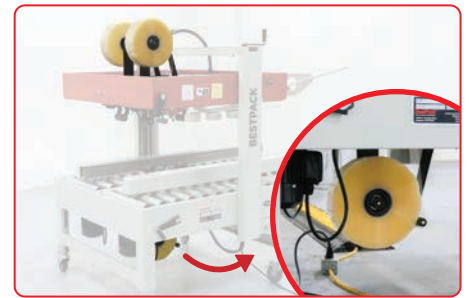

3 TAPE HEAD DESIGN

Equipped with 2 top tape heads and 1 bottom tape head providing extra security on the top of your cartons.

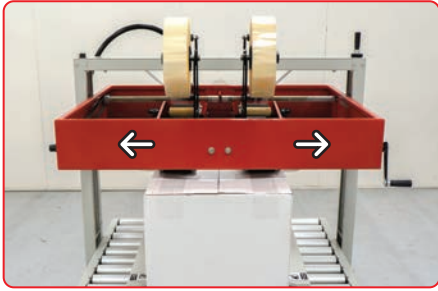

ADJUSTABLE TOP TAPE HEAD

Adjust the position of the top tape heads allowing you to bring in or out the seals on your carton.

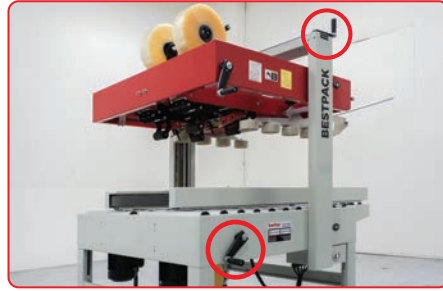

MANUAL HEIGHT & WIDTH ADJUSTMENT

Manually adjust the top mast and side belts based to get the right fit for your carton.



VERSATILE TOP TAPE HEAD CAVITY

Swap between, 2", 3" or 6" tape heads anytime.

MACHINE FOOTPRINT

Specifications based on MSAG-3HEB

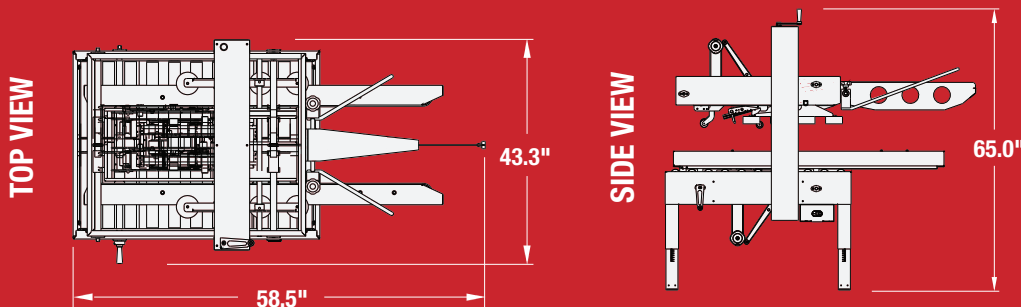

Note: Dimensions are all subject to change without prior notification.

OPTIONS

- Infeed/Exit Conveyor w/ L-Bracket Stabilizer
- Heavy Duty Locking Casters
- Left or Right Justified

POPULAR MSAG MODELS

PLEASE REFER TO COMPARISON CHART FOR COMPLETE LIST OF MODELS.

MODEL	MACHINE DIMENSIONS LENGTH x WIDTH x HEIGHT	CARTON RANGE* LENGTH (min. - max.) x WIDTH (min. - max.) x HEIGHT (min. - max.)	CONVEYOR HEIGHT HEIGHT (min. - max.)	CARTONS PER MIN.***	SHIPPING WEIGHT (LBS)	POWER REQUIREMENTS
MSAG-3HEB** 3" Tape Head	(58.5") x (43.3") x (65.0")	(6.0" - U) x (8.5" - 31.0") x (6.25" - 20.25")	(20.5" - 30.0")	Up to 35	575	110 Volts 60 Hz

INFORMATION SUBJECT TO CHANGE WITHOUT NOTICE.

U - UNLIMITED
* OUTSIDE DIMENSIONS ONLY
** HIGH SPEED
*** BASED ON CUSTOMER APPLICATION



For more information please go to:
WWW.BESTPACK.COM or call us at **1.888.588.2378**